



317

Hydraulic Excavator

Technical Specifications

Configurations and features may vary by region. Please consult your Cat® dealer for availability in your area.

Table of Contents

Specifications	2
Engine	2
Swing Mechanism	2
Weights	2
Track	2
Drive	2
Hydraulic System	2
Service Refill Capacities	2
Standards	3
Sound Performance	3
Air Conditioning System	3
Operating Weights and Ground Pressures	3
Major Component Weights	4
Dimensions	5
Working Ranges and Forces	7
Reach Boom Lift Capacities	9
Variable Angle Boom Lift Capacities	13
Bucket Specifications and Compatibility:	
Europe	17
Australia and New Zealand	20
Attachments Offering Guide:	
Europe	21
Australia and New Zealand	25
Standard and Optional Equipment	26
Dealer Installed Kits and Attachments	28
Cab Options	29
317 Environmental Declaration	30

317 Hydraulic Excavator Specifications

Engine

Engine Model	Cat® C4.4	
Net Power		
ISO 9249	96.9 kW	130 hp
ISO 9249 (DIN)	132 hp (metric)	
Engine Power		
ISO 14396	97.9 kW	131 hp
ISO 14396 (DIN)	133 hp (metric)	
Bore	105 mm	4 in
Stroke	127 mm	5 in
Displacement	4.4 L	269 in ³
Biodiesel Capability	up to B20 ⁽¹⁾	

- Meets U.S. EPA Tier 4 Final, EU Stage V, and Japan 2014 emission standards.
- No engine power derate required below 3000 m (9,840 ft) altitude.
- Advertised power is tested per the specified standard in effect at the time of manufacture.
- Net power advertised is the power available at the flywheel when the engine is equipped with fan, air intake system, exhaust system and alternator.
- Engine speed at 2,200 rpm.

⁽¹⁾Cat diesel engines are required to use ULSD (ultra-low sulfur diesel fuel with 15 ppm of sulfur or less) or ULSD blended with the following lower-carbon intensity fuels up to:

- ✓ 20% biodiesel FAME (fatty acid methyl ester)*
- ✓ 100% renewable diesel, HVO (hydrogenated vegetable oil) and GTL (gas-to-liquid) fuels

Refer to guidelines for successful application. Please consult your Cat dealer or “Caterpillar Machine Fluids Recommendations” (SEBU6250) for details.

*Engines with no aftertreatment devices can use higher blends, up to 100% biodiesel.

Swing Mechanism

Swing Speed	8.7 rpm	
Maximum Swing Torque	64.6 kN·m	47,647 lbf-ft

Weights

Operating Weight	17 800 kg	39,300 lb
------------------	-----------	-----------

- Long undercarriage, Reach boom, R3.1 (10'2") stick, GD 1.00 m³ (1.31 yd³) bucket, 500 mm (20") triple grouser shoes and 3.57 mt (7,870 lb) counterweight.

Operating Weight	18 100 kg	39,800 lb
------------------	-----------	-----------

- Long undercarriage, Reach boom, R3.1 (10'2") stick, GD 1.00 m³ (1.31 yd³) bucket, 600 mm (24") triple grouser shoes and 3.57 mt (7,870 lb) counterweight.

Track

Optional Track Shoes Width	500 mm	20 in
Optional Track Shoes Width	600 mm	24 in
Optional Track Shoes Width	700 mm	28 in
Optional Track Shoes Width	790 mm	31 in
Number of Shoes (each side)	44	
Number of Track Rollers (each side)	7	
Number of Carrier Rollers (each side)	2	

Drive

Gradeability	35°/70%	
Maximum Travel Speed	5.3 km/h	3.3 mph
Maximum Drawbar Pull	157 kN	35,295 lbf

Hydraulic System

Main System – Maximum Flow – Implement	296 L/min	78 gal/min
Maximum Pressure – Equipment	35 000 kPa	5,076 psi
Maximum Pressure – Travel	35 000 kPa	5,076 psi
Maximum Pressure – Swing	25 800 kPa	3,741 psi
Boom Cylinder – Bore	110 mm	4.3 in
Boom Cylinder – Stroke	1193 mm	47.0 in
VA Boom Cylinder – Bore	140 mm	5.5 in
VA Boom Cylinder – Stroke	865 mm	34.1 in
Stick Cylinder – Bore	120 mm	4.7 in
Stick Cylinder – Stroke	1331 mm	52.4 in
Bucket Cylinder – Bore	105 mm	4.1 in
Bucket Cylinder – Stroke	1039 mm	40.9 in

Service Refill Capacities

Fuel Tank Capacity	271 L	71.6 gal
Cooling System	28 L	7.4 gal
Engine Oil	15 L	4.0 gal
Final Drive (each)	6 L	1.6 gal
Hydraulic System (including tank)	94 L	24.8 gal
Hydraulic Tank	87 L	23.0 gal
Diesel Exhaust Fluid (DEF) Tank	22 L	5.9 gal

317 Hydraulic Excavator Specifications

Standards

Brakes	ISO 10265:2008
Cab/ROPS	ISO 12117-2:2008
Cab/FOGS	ISO 10262:1998

Sound Performance

ISO 6395 (external)	101 dB(A)
ISO 6396 (inside cab)	70 dB(A)

- When properly installed and maintained, the cab offered by Caterpillar, when tested with doors and windows closed according to ANSI/SAE J1166 OCT98, meets OSHA and MSHA requirements for operator sound exposure limits in effect at time of manufacture.
- Hearing protection may be needed when operating with an open operator station and cab (when not properly maintained or doors/windows open) for extended periods or in a noisy environment.

Air Conditioning System

The air conditioning system on this machine contains the fluorinated greenhouse gas refrigerant R134a (Global Warming Potential = 1430). The system contains 0.9 kg of refrigerant which has a CO₂ equivalent 1.287 metric tonne.

Operating Weights and Ground Pressures

	500 mm (20") Triple Grouser Shoes		600 mm (24") Triple Grouser Shoes		700 mm (28") Triple Grouser Shoes		790 mm (31") Triple Grouser Shoes	
	Weight	Ground Pressure	Weight	Ground Pressure	Weight	Ground Pressure	Weight	Ground Pressure
	kg (lb)	kPa (psi)	kg (lb)	kPa (psi)	kg (lb)	kPa (psi)	kg (lb)	kPa (psi)
Base machine with 3.57 mt (7,870 lb) Counterweight and Long Undercarriage								
Reach Boom + R2.6 (8'6") Stick + 0.91 m ³ (1.19 yd ³) GD Bucket	17 700 (39,100)	50.4 (7.3)	18 000 (39,600)	42.5 (6.2)	18 200 (40,100)	36.9 (5.4)	18 600 (41,000)	33.4 (4.8)
Reach Boom + R3.1 (10'2") Stick + 0.91 m ³ (1.19 yd ³) GD Bucket	17 800 (39,300)	50.6 (7.3)	18 000 (39,800)	42.7 (6.2)	18 300 (40,300)	37.1 (5.4)	18 700 (41,100)	33.5 (4.9)
Reach Boom + R2.6 (8'6") Stick + 1.00 m ³ (1.31 yd ³) GD Bucket	17 800 (39,200)	50.5 (7.3)	18 000 (39,700)	42.6 (6.2)	18 200 (40,200)	37.0 (5.4)	18 600 (41,000)	33.5 (4.9)
Reach Boom + R3.1 (10'2") Stick + 1.00 m ³ (1.31 yd ³) GD Bucket	17 800 (39,300)	50.7 (7.4)	18 100 (39,800)	42.8 (6.2)	18 300 (40,400)	37.1 (5.4)	18 700 (41,200)	33.6 (4.9)
Variable Angle Boom + R2.25 (7'5") Stick + 0.91 m ³ (1.19 yd ³) GD Bucket	18 300 (40,400)	52.0 (7.5)	18 500 (40,800)	43.9 (6.4)	18 800 (41,400)	38.1 (5.5)	19 200 (42,200)	34.4 (5.0)
Variable Angle Boom + R2.6 (8'6") Stick + 0.91 m ³ (1.19 yd ³) GD Bucket	18 300 (40,400)	52.1 (7.6)	18 600 (40,900)	44.0 (6.4)	18 800 (41,500)	38.2 (5.5)	19 200 (42,300)	34.5 (5.0)
Variable Angle Boom + R2.25 (7'5") Stick + 1.00 m ³ (1.31 yd ³) GD Bucket	18 300 (40,400)	52.1 (7.6)	18 600 (40,900)	43.9 (6.4)	18 800 (41,400)	38.1 (5.5)	19 200 (42,300)	34.5 (5.0)
Variable Angle Boom + R2.6 (8'6") Stick + 1.00 m ³ (1.31 yd ³) GD Bucket	18 400 (40,500)	52.2 (7.6)	18 600 (41,000)	44.1 (6.4)	18 800 (41,500)	38.2 (5.5)	19 200 (42,400)	34.6 (5.0)

All operating weights include a 90% fuel tank with 75 kg (165 lb) operator.

317 Hydraulic Excavator Specifications

Major Component Weights

	kg	lb
Base Machine (with 3.57 mt [7,870 lb] counterweight, upper frame, long undercarriage – does not include boom, stick, bucket, boom cylinders, stick cylinder, bucket cylinders, tracks, 90% fuel tank and 75 kg [165 lb] operator).		
For use with Reach Boom	12 200	26,900
For use with Variable Angle Boom	12 200	26,900
Track Shoes:		
500 mm (20") Triple Grouser Track Shoes	2110	4,660
600 mm (24") Triple Grouser Track Shoes	2340	5,160
700 mm (28") Triple Grouser Track Shoes with Additional Steps	2580	5,680
790 mm (31") Triple Grouser Track Shoes with Additional Steps	2970	6,540
Two Boom Cylinders	300	670
Weight of 90% Fuel Tank and 75 kg (165 lb) Operator	300	660
Counterweight:		
3.57 mt (7,870 lb) Counterweight	3570	7,870
Swing Frame	1700	3,760
Undercarriage:		
Base Frame with Long Undercarriage	3900	8,600
Booms (including lines, pins, stick cylinder):		
Reach Boom 5.1 m (16'9")	1320	2,910
Variable Angle Boom (2.64 m [8'8"] Stub + 2.6 m [8'6"] Fore)	1940	4,270
Sticks (including lines, pins, bucket cylinder, bucket linkage):		
Reach Stick R2.6 (8'6")	810	1,780
Reach Stick R3.1 (10'2")	880	1,940
Reach Stick R2.25 (7'5") including HP, MP, QC AUX line	760	1,680
Buckets (without linkage):		
0.62 m ³ (0.81 yd ³) GD Bucket	730	1,610
0.91 m ³ (1.19 yd ³) GD Bucket	690	1,510
1.00 m ³ (1.31 yd ³) GD Bucket	740	1,620
Quick Coupler:		
Pin Grabber Quick Coupler	260	580

317 Hydraulic Excavator Specifications

Dimensions

All dimensions are approximate and may vary depending on bucket selection.

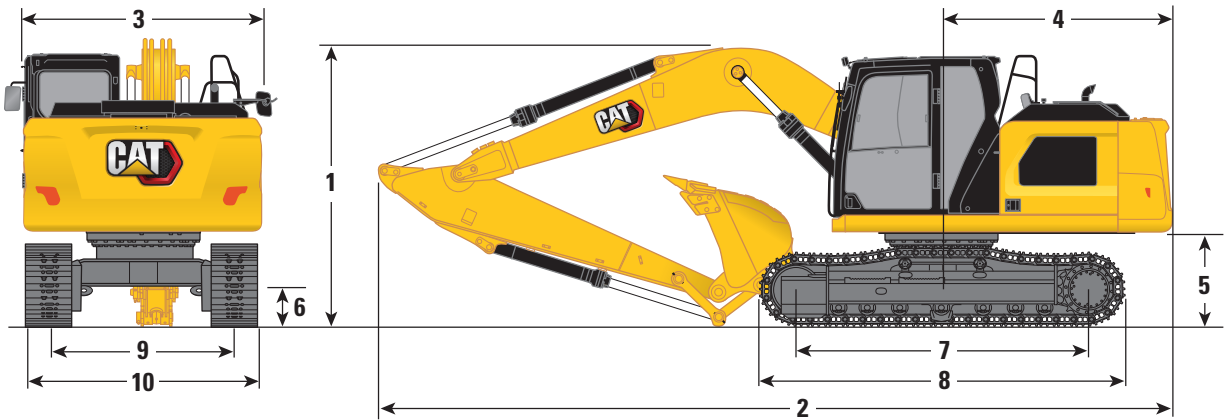

Boom Option	Reach Boom 5.1 m (16'9")			
	Reach Stick R2.6 (8'6")		Reach Stick R3.1 (10'2")	
1 Machine Height:				
Top of Cab Height	2930 mm	9'7"	2930 mm	9'7"
Top of FOGS Height	3070 mm	10'1"	3070 mm	10'1"
Handrail Height	2940 mm	9'8"	2940 mm	9'8"
With Boom/Stick/Bucket Installed (with stick cylinder lines)	2980 mm	9'9"	3120 mm	10'3"
With Boom/Stick Installed (with stick cylinder lines)	2870 mm	9'5"	2970 mm	9'9"
With Boom Installed (with stick cylinder lines)	2460 mm	8'1"	2460 mm	8'1"
2 Machine Length:				
With Boom/Stick/Bucket Installed (with stick cylinder lines)	8550 mm	28'1"	8570 mm	28'1"
With Boom/Stick Installed (with stick cylinder lines)	8520 mm	27'11"	8560 mm	28'1"
With Boom Installed (with stick cylinder lines)	7560 mm	24'10"	7560 mm	24'10"
3 Upperframe Width	2540 mm	8'4"	2540 mm	8'4"
4 Tail Swing Radius:				
3.57 mt (7,870 lb) Counterweight	2500 mm	8'2"	2500 mm	8'2"
5 Counterweight Clearance	1010 mm	3'4"	1010 mm	3'4"
6 Ground Clearance	430 mm	1'5"	430 mm	1'5"
7 Length to Center of Rollers	3170 mm	10'5"	3170 mm	10'5"
8 Track Length	3970 mm	13'0"	3970 mm	13'0"
9 Track Gauge	1990 mm	6'6"	1990 mm	6'6"
10 Undercarriage Width:				
500 mm (20") Shoes	2490 mm	8'2"	2490 mm	8'2"
600 mm (24") Shoes	2590 mm	8'6"	2590 mm	8'6"
700 mm (28") Shoes (with steps)	2690 mm	8'10"	2690 mm	8'10"
790 mm (31") Shoes (with steps)	2780 mm	9'1"	2780 mm	9'1"
Bucket Type	GD		GD	
Bucket Capacity	1.00 m ³	1.31 yd ³	1.00 m ³	1.31 yd ³
Bucket Tip Radius	1300 mm	4'3"	1300 mm	4'3"

317 Hydraulic Excavator Specifications

Dimensions

All dimensions are approximate and may vary depending on bucket selection.

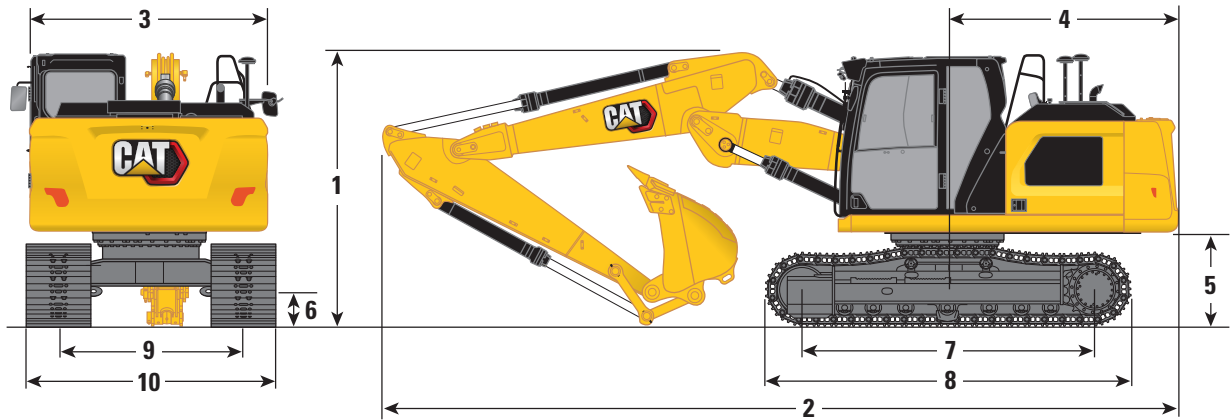

Boom Option

Variable Angle Boom
2.64 m/2.6 m (8'8"/8'6")

Stick Options

Reach Stick
R2.25 (7'5")

Reach Stick
R2.6 (8'6")

	Reach Stick R2.25 (7'5")	Reach Stick R2.6 (8'6")
1 Machine Height:		
Top of Cab Height	2930 mm 9'7"	2930 mm 9'7"
Top of FOGS Height	3070 mm 10'1"	3070 mm 10'1"
Handrail Height	2940 mm 9'8"	2940 mm 9'8"
With Boom/Stick/Bucket Installed (with stick cylinder lines)	2840 mm 9'4"	2990 mm 9'10"
With Boom/Stick Installed (with stick cylinder lines)	2710 mm 8'11"	2800 mm 9'2"
With Boom Installed (with stick cylinder lines)	2250 mm 7'5"	2250 mm 7'5"
2 Machine Length:		
With Boom/Stick/Bucket Installed (with stick cylinder lines)	8620 mm 28'3"	8610 mm 28'3"
With Boom/Stick Installed (with stick cylinder lines)	8620 mm 28'3"	8620 mm 28'3"
With Boom Installed (with stick cylinder lines)	7680 mm 25'2"	7680 mm 25'2"
3 Upperframe Width	2540 mm 8'4"	2540 mm 8'4"
4 Tail Swing Radius:		
3.57 mt (7,870 lb) Counterweight	2500 mm 8'2"	2500 mm 8'2"
5 Counterweight Clearance	1010 mm 3'4"	1010 mm 3'4"
6 Ground Clearance	430 mm 1'5"	430 mm 1'5"
7 Length to Center of Rollers	3170 mm 10'5"	3170 mm 10'5"
8 Track Length	3970 mm 13'0"	3970 mm 13'0"
9 Track Gauge	1990 mm 6'6"	1990 mm 6'6"
10 Undercarriage Width:		
500 mm (20") Shoes	2490 mm 8'2"	2490 mm 8'2"
600 mm (24") Shoes	2590 mm 8'6"	2590 mm 8'6"
700 mm (28") Shoes (with steps)	2690 mm 8'10"	2690 mm 8'10"
790 mm (31") Shoes (with steps)	2780 mm 9'1"	2780 mm 9'1"
Bucket Type	GD	GD
Bucket Capacity	1.00 m ³ 1.31 yd ³	1.00 m ³ 1.31 yd ³
Bucket Tip Radius	1300 mm 4'3"	1300 mm 4'3"

317 Hydraulic Excavator Specifications

Working Ranges and Forces

All dimensions are approximate and may vary depending on bucket selection.

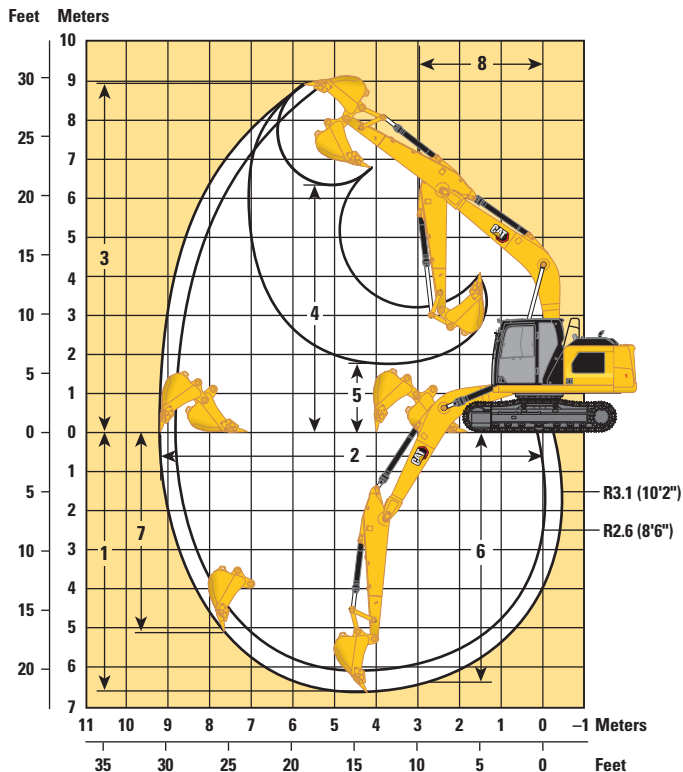

Boom Option

Reach Boom 5.1 m (16'9")

Stick Options

Reach Stick R2.6 (8'6")

Reach Stick R3.1 (10'2")

	Reach Stick R2.6 (8'6")		Reach Stick R3.1 (10'2")	
1 Maximum Digging Depth	6100 mm	20'0"	6600 mm	21'8"
2 Maximum Reach at Ground Line	8790 mm	28'10"	9200 mm	30'2"
3 Maximum Cutting Height	8940 mm	29'4"	8990 mm	29'6"
4 Maximum Loading Height	6270 mm	20'7"	6370 mm	20'11"
5 Minimum Loading Height	2290 mm	7'6"	1790 mm	5'10"
6 Maximum Depth Cut for 2440 mm (8'0") Level Bottom	5880 mm	19'3"	6380 mm	20'11"
7 Maximum Vertical Wall Digging Depth	4980 mm	16'4"	5150 mm	16'11"
8 Minimum Working Equipment Radius	2980 mm	9'9"	2930 mm	9'7"
Bucket Digging Force (ISO)	123 kN	27,650 lbf	123 kN	27,650 lbf
Stick Digging Force (ISO)	80 kN	17,980 lbf	71 kN	15,960 lbf
Bucket Type	GD		GD	
Bucket Capacity	1.00 m ³	1.31 yd ³	1.00 m ³	1.31 yd ³
Bucket Tip Radius	1300 mm	4'3"	1300 mm	4'3"

317 Hydraulic Excavator Specifications

Working Ranges and Forces

All dimensions are approximate and may vary depending on bucket selection.

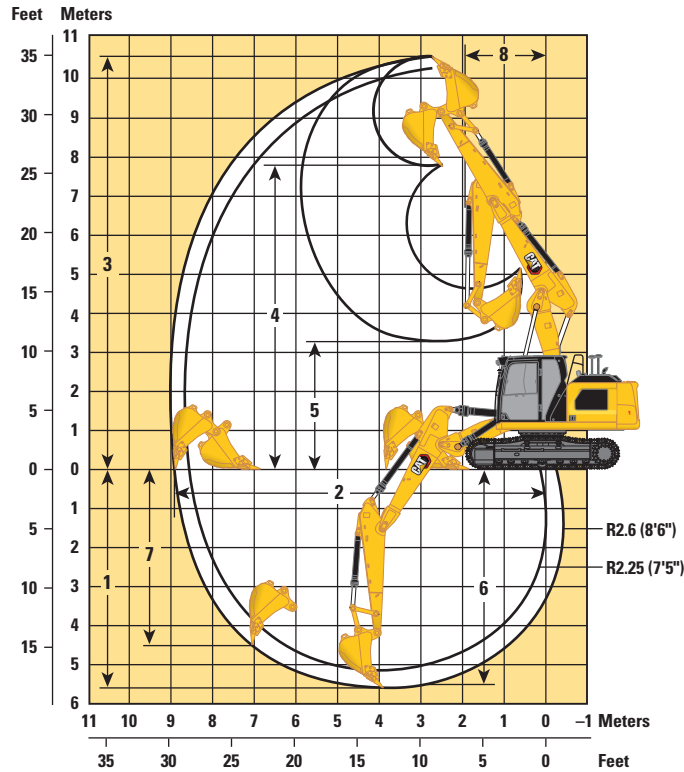

Boom Option

Variable Angle Boom
2.64 m/2.6 m (8'8"/8'6")

Stick Options

Reach Stick
R2.25 (7'5")

Reach Stick
R2.6 (8'6")

	Reach Stick R2.25 (7'5")		Reach Stick R2.6 (8'6")	
1 Maximum Digging Depth	5180 mm	17'0"	5520 mm	18'1"
2 Maximum Reach at Ground Line	8650 mm	28'5"	8980 mm	29'6"
3 Maximum Cutting Height	10 270 mm	33'8"	10 570 mm	34'8"
4 Maximum Loading Height	7530 mm	24'8"	7850 mm	25'9"
5 Minimum Loading Height	3580 mm	11'9"	3280 mm	10'9"
6 Maximum Depth Cut for 2440 mm (8'0") Level Bottom	5040 mm	16'6"	5400 mm	17'9"
7 Maximum Vertical Wall Digging Depth	3120 mm	10'3"	4510 mm	14'10"
8 Minimum Working Equipment Radius	1810 mm	5'11"	1980 mm	6'6"
Bucket Digging Force (ISO)	123 kN	27,650 lbf	123 kN	27,650 lbf
Stick Digging Force (ISO)	88 kN	19,780 lbf	80 kN	17,980 lbf
Bucket Type	GD		GD	
Bucket Capacity	1.00 m ³	1.31 yd ³	1.00 m ³	1.31 yd ³
Bucket Tip Radius	1300 mm	4'3"	1300 mm	4'3"

317 Hydraulic Excavator Specifications

Reach Boom Lift Capacities – Counterweight: 3.57 mt (7,870 lb) – without Bucket

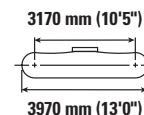
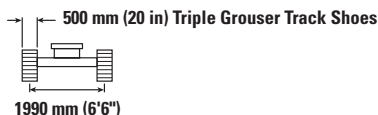

Reach Boom	1500 mm/5'0"		3000 mm/10'0"		4500 mm/15'0"		6000 mm/20'0"		7500 mm/25'0"		mm ft/in		
	kg lb	kg lb	kg lb	kg lb	kg lb	kg lb	kg lb	kg lb	kg lb	kg lb	kg lb	mm ft/in	
7500 mm 25'0"					*7,700	*7,700					*3350 *7,450	*3350 *7,450	4770 15'1"
6000 mm 20'0"							*3600 *6,650	*3600 *6,650			*2950 *6,450	*2950 *6,450	6190 20'0"
4500 mm 15'0"					*4650 *10,050	*4650 *10,050	*4300 *9,450	3650 7,800			*2850 *6,200	*2850 *6,200	7020 22'10"
3000 mm 10'0"			*8900 *18,900	*8900 *18,900	*5900 *12,700	5300 11,450	*4850 *10,500	3500 7,550			*2900 *6,300	2550 5,600	7450 24'4"
1500 mm 5'0"					*7250 *15,600	5000 10,750	5300 11,450	3350 7,250	*3500 2450		*3050 *6,750	2450 5,300	7560 24'9"
0 mm 0'0"			*6200 *14,200	*6200 *14,200	8000 17,150	4800 10,250	5200 11,150	3250 7,000			*3450 *7,600	2450 5,400	7370 24'2"
-1500 mm -5'0"	kg lb	*5650 *12,650	*5650 *12,650	*10 050 *22,950	8600 18,450	7900 17,000	4700 10,100	5150 11,050	3200 6,900		*4200 *9,300	2700 5,950	6850 22'4"
-3000 mm -10'0"	kg lb	*9900 *22,300	*9900 *22,300	*10 750 *23,250	8750 18,750	*7450 *16,050	4750 10,250				5350 *11,800	3350 7,400	5900 19'2"
-4500 mm -15'0"	kg lb			*7750 *16,400	*7750 *16,400						*5450 *11,900	5400 *11,900	4240 13'6"

Reach Boom Lift Capacities – Counterweight: 3.57 mt (7,870 lb) – without Bucket

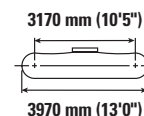
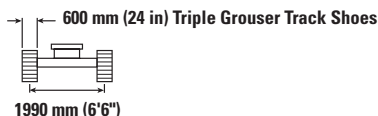

Reach Boom	1500 mm/5'0"		3000 mm/10'0"		4500 mm/15'0"		6000 mm/20'0"		7500 mm/25'0"		mm ft/in		
	kg lb	kg lb	kg lb	kg lb	kg lb	kg lb	kg lb	kg lb	kg lb	kg lb	kg lb	mm ft/in	
7500 mm 25'0"					*7,700	*7,700					*3350 *7,450	*3350 *7,450	4770 15'1"
6000 mm 20'0"							*3600 *6,650	*3600 *6,650			*2950 *6,450	*2950 *6,450	6190 20'0"
4500 mm 15'0"					*4650 *10,050	*4650 *10,050	*4300 *9,450	3700 7,900			*2850 *6,200	*2850 *6,200	7020 22'10"
3000 mm 10'0"			*8900 *18,900	*8900 *18,900	*5900 *12,700	5350 11,550	*4850 *10,500	3550 7,650			*2900 *6,300	2550 5,650	7450 24'4"
1500 mm 5'0"					*7250 *15,600	5050 10,850	5400 11,550	3400 7,300	*3500 2500		*3050 *6,750	2450 5,400	7560 24'9"
0 mm 0'0"			*6200 *14,200	*6200 *14,200	*8050 17,350	4850 10,400	5250 11,300	3300 7,050			*3450 *7,600	2500 5,500	7370 24'2"
-1500 mm -5'0"	kg lb	*5650 *12,650	*5650 *12,650	*10 050 *22,950	8700 18,650	8000 17,200	4750 10,250	5200 11,200	3250 6,950		*4200 *9,300	2750 6,050	6850 22'4"
-3000 mm -10'0"	kg lb	*9900 *22,300	*9900 *22,300	*10 750 *23,250	8800 18,950	*7450 *16,050	4800 10,350				*5350 *11,800	3400 7,500	5900 19'2"
-4500 mm -15'0"	kg lb			*7750 *16,400	*7750 *16,400						*5450 *11,900	5400 *11,900	4240 13'6"



ISO 10567



* Indicates that the load is limited by hydraulic lifting capacity rather than tipping load. The above loads are in compliance with hydraulic excavator lift capacity standard ISO 10567:2007. They do not exceed 87% of hydraulic lifting capacity or 75% of tipping load. Weight of all lifting accessories must be deducted from the above lifting capacities. Lifting capacities are based on the machine standing on a firm, uniform supporting surface. The use of a work tool attachment point to handle/lift objects, could affect the machine lift performance.

Lift capacity stays with ±5% for all available track shoes.

Always refer to the appropriate Operation and Maintenance Manual for specific product information.

317 Hydraulic Excavator Specifications

Reach Boom Lift Capacities – Counterweight: 3.57 mt (7,870 lb) – without Bucket

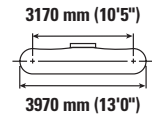
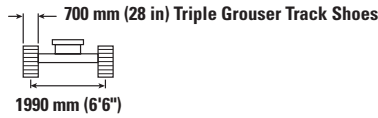
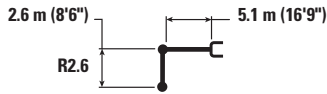

		1500 mm/5'0"		3000 mm/10'0"		4500 mm/15'0"		6000 mm/20'0"		7500 mm/25'0"		mm ft/in		
7500 mm 25'0"	kg lb					*7,700	*7,700					*3350 *7,450	*3350 *7,450	4770 15'1"
6000 mm 20'0"	kg lb							*3600 *6,650	*3600 *6,650			*2950 *6,450	*2950 *6,450	6190 20'0"
4500 mm 15'0"	kg lb					*4650 *10,050	*4650 *10,050	*4300 *9,450	3700 8,000			*2850 *6,200	*2850 *6,200	7020 22'10"
3000 mm 10'0"	kg lb			*8900 *18,900	*8900 *18,900	*5900 *12,700	5400 11,650	*4850 *10,500	3600 7,700			*2900 *6,300	2600 5,700	7450 24'4"
1500 mm 5'0"	kg lb					*7250 *15,600	5100 10,950	5450 11,700	3450 7,400	*3500 2500		*3050 *6,750	2500 5,450	7560 24'9"
0 mm 0'0"	kg lb			*6200 *14,200	*6200 *14,200	*8050 *17,400	4900 10,500	5300 11,450	3350 7,150			*3450 *7,600	2550 5,550	7370 24'2"
-1500 mm -5'0"	kg lb	*5650 *12,650	*5650 *12,650	*10 050 *22,950	8800 18,850	8100 17,400	4800 10,350	5250 11,350	3300 7,050			*4200 *9,300	2800 6,100	6850 22'4"
-3000 mm -10'0"	kg lb	*9900 *22,300	*9900 *22,300	*10 750 *23,250	8900 19,150	*7450 *16,050	4850 10,450					*5350 *11,800	3400 7,550	5900 19'2"
-4500 mm -15'0"	kg lb			*7750 *16,400	*7750 *16,400							*5450 *11,900	*5450 *11,900	4240 13'6"

Reach Boom Lift Capacities – Counterweight: 3.57 mt (7,870 lb) – without Bucket

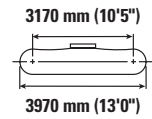
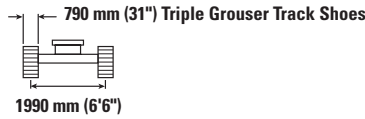
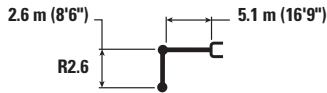

		1500 mm/5'0"		3000 mm/10'0"		4500 mm/15'0"		6000 mm/20'0"		7500 mm/25'0"		mm ft/in		
7500 mm 25'0"	kg lb					*7,700	*7,700					*3350 *7,450	*3350 *7,450	4770 15'1"
6000 mm 20'0"	kg lb							*3600 *6,650	*3600 *6,650			*2950 *6,450	*2950 *6,450	6190 20'0"
4500 mm 15'0"	kg lb					*4650 *10,050	*4650 *10,050	*4300 *9,450	3800 8,100			*2850 *6,200	*2850 *6,200	7020 22'10"
3000 mm 10'0"	kg lb			*8900 *18,900	*8900 *18,900	*5900 *12,700	5500 11,850	*4850 *10,500	3650 7,850			*2900 *6,300	2650 5,800	7450 24'4"
1500 mm 5'0"	kg lb					*7250 *15,600	5200 11,150	*5450 *11,850	3500 7,550	*3500 2550		*3050 *6,750	2550 5,550	7560 24'9"
0 mm 0'0"	kg lb			*6200 *14,200	*6200 *14,200	*8050 *17,400	5000 10,700	5450 11,650	3400 7,300			*3450 *7,600	2600 5,650	7370 24'2"
-1500 mm -5'0"	kg lb	*5650 *12,650	*5650 *12,650	*10 050 *22,950	8950 19,200	*8150 *17,650	4900 10,550	5400 11,550	3350 7,200			*4200 *9,300	2850 6,250	6850 22'4"
-3000 mm -10'0"	kg lb	*9900 *22,300	*9900 *22,300	*10 750 *23,250	9100 19,500	*7450 *16,050	4950 10,650					*5350 *11,800	3500 7,700	5900 19'2"
-4500 mm -15'0"	kg lb			*7750 *16,400	*7750 *16,400							*5450 *11,900	*5450 *11,900	4240 13'6"



ISO 10567



* Indicates that the load is limited by hydraulic lifting capacity rather than tipping load. The above loads are in compliance with hydraulic excavator lift capacity standard ISO 10567:2007. They do not exceed 87% of hydraulic lifting capacity or 75% of tipping load. Weight of all lifting accessories must be deducted from the above lifting capacities. Lifting capacities are based on the machine standing on a firm, uniform supporting surface. The use of a work tool attachment point to handle/lift objects, could affect the machine lift performance.

Lift capacity stays with ±5% for all available track shoes.

Always refer to the appropriate Operation and Maintenance Manual for specific product information.

317 Hydraulic Excavator Specifications

Reach Boom Lift Capacities – Counterweight: 3.57 mt (7,870 lb) – without Bucket

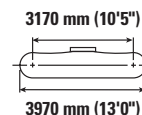
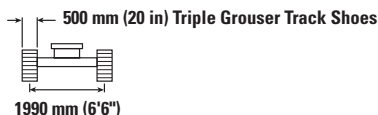

		1500 mm/5'0"		3000 mm/10'0"		4500 mm/15'0"		6000 mm/20'0"		7500 mm/25'0"		mm ft/in		
7500 mm 25'0"	kg lb											*2700 *6,050	*2700 *6,050	5380 17'2"
6000 mm 20'0"	kg lb							*3650 *7,550	*3650 *7,550			*2450 *5,400	*2450 *5,400	6670 21'7"
4500 mm 15'0"	kg lb							*3900 *8,500	3700 7,900			*2400 *5,250	*2400 *5,250	7440 24'3"
3000 mm 10'0"	kg lb			*7500 *15,950	*7500 *15,950	*5300 *11,450	*5300 *11,450	*4500 *9,700	3550 7,600	*3600 *7,100	2500 5,400	*2450 *5,400	2350 5,150	7850 25'8"
1500 mm 5'0"	kg lb			*8250 *19,750	*8250 *19,350	*6750 *14,550	5050 10,800	*5150 *11,200	3350 7,250	3850 8,200	2450 5,250	*2650 *5,800	2250 4,900	7960 26'1"
0 mm 0'0"	kg lb			*7150 *16,450	*7150 *16,450	*7750 *16,800	4750 10,250	5200 11,150	3250 6,950	3750 8,100	2400 5,100	*3000 *6,550	2250 4,950	7780 25'5"
-1500 mm -5'0"	kg lb	*5400 *12,050	*5400 *12,050	*9700 *22,100	8500 18,200	7850 16,850	4650 10,000	5100 10,950	3150 6,800			*3600 *7,950	2450 5,400	7280 23'10"
-3000 mm -10'0"	kg lb	*8700 *19,450	*8700 *19,450	*11,400 *24,650	8600 18,400	*7750 *16,700	4650 10,050	5100 11,000	3150 6,850			4700 10,400	2950 6,500	6400 20'10"
-4500 mm -15'0"	kg lb			*9100 *19,350	8850 18,950	*6150 *12,950	4800 10,400					*5450 *12,000	4300 9,700	4920 15'9"

Reach Boom Lift Capacities – Counterweight: 3.57 mt (7,870 lb) – without Bucket

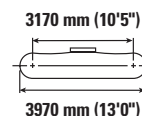
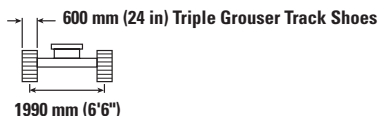

		1500 mm/5'0"		3000 mm/10'0"		4500 mm/15'0"		6000 mm/20'0"		7500 mm/25'0"		mm ft/in		
7500 mm 25'0"	kg lb											*2700 *6,050	*2700 *6,050	5380 17'2"
6000 mm 20'0"	kg lb							*3650 *7,550	*3650 *7,550			*2450 *5,400	*2450 *5,400	6670 21'7"
4500 mm 15'0"	kg lb							*3900 *8,500	3700 7,950			*2400 *5,250	*2400 *5,250	7440 24'3"
3000 mm 10'0"	kg lb			*7500 *15,950	*7500 *15,950	*5300 *11,450	*5300 *11,450	*4500 *9,700	3550 7,650	*3600 *7,100	2550 5,450	*2450 *5,400	2350 5,200	7850 25'8"
1500 mm 5'0"	kg lb			*8250 *19,750	*8250 *19,550	*6750 *14,550	5100 10,950	*5150 *11,200	3400 7,300	3850 8,300	2450 5,300	*2650 *5,800	2250 4,950	7960 26'1"
0 mm 0'0"	kg lb			*7150 *16,450	*7150 *16,450	*7750 *16,800	4800 10,400	5250 11,250	3250 7,000	3800 8,200	2400 5,150	*3000 *6,550	2300 5,000	7780 25'5"
-1500 mm -5'0"	kg lb	*5400 *12,050	*5400 *12,050	*9700 *22,100	8600 18,450	7950 17,050	4700 10,150	5150 11,100	3200 6,850			*3600 *7,950	2500 5,450	7280 23'10"
-3000 mm -10'0"	kg lb	*8700 *19,450	*8700 *19,450	*11,400 *24,650	8650 18,600	*7750 *16,700	4700 10,150	5150 11,150	3200 6,900			4750 10,500	2950 6,550	6400 20'10"
-4500 mm -15'0"	kg lb			*9100 *19,350	8900 19,200	*6150 *12,950	4850 10,500					*5450 *12,000	4350 9,800	4920 15'9"



ISO 10567



* Indicates that the load is limited by hydraulic lifting capacity rather than tipping load. The above loads are in compliance with hydraulic excavator lift capacity standard ISO 10567:2007. They do not exceed 87% of hydraulic lifting capacity or 75% of tipping load. Weight of all lifting accessories must be deducted from the above lifting capacities. Lifting capacities are based on the machine standing on a firm, uniform supporting surface. The use of a work tool attachment point to handle/lift objects, could affect the machine lift performance.

Lift capacity stays with ±5% for all available track shoes.

Always refer to the appropriate Operation and Maintenance Manual for specific product information.

317 Hydraulic Excavator Specifications

Reach Boom Lift Capacities – Counterweight: 3.57 mt (7,870 lb) – without Bucket

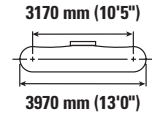
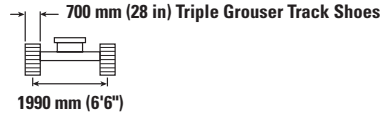
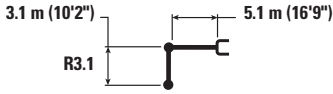

		1500 mm/5'0"		3000 mm/10'0"		4500 mm/15'0"		6000 mm/20'0"		7500 mm/25'0"		mm ft/in		
7500 mm 25'0"	kg lb											*2700 *6,050	*2700 *6,050	5380 17'2"
6000 mm 20'0"	kg lb							*3650 *7,550	*3650 *7,550			*2450 *5,400	*2450 *5,400	6670 21'7"
4500 mm 15'0"	kg lb							*3900 *8,500	3750 8,050			*2400 *5,250	*2400 *5,250	7440 24'3"
3000 mm 10'0"	kg lb			*7500 *15,950	*7500 *15,950	*5300 *11,450	*5300 *11,450	*4500 *9,700	3600 7,750	*3600 *7,100	2600 5,500	*2450 *5,400	2400 5,250	7850 25'8"
1500 mm 5'0"	kg lb			*8250 *19,750	*8250 *19,750	*6750 *14,550	5150 11,050	*5150 *11,200	3450 7,400	3900 8,400	2500 5,350	*2650 *5,800	2300 5,000	7960 26'1"
0 mm 0'0"	kg lb			*7150 *16,450	*7150 *16,450	*7750 *16,800	4900 10,500	5300 11,400	3300 7,100	3850 8,300	2450 5,250	*3000 *6,550	2300 5,100	7780 25'5"
-1500 mm -5'0"	kg lb	*5400 *12,050	*5400 *12,050	*9700 *22,100	8700 18,650	8050 17,300	4750 10,250	5200 11,250	3250 6,950			*3600 *7,950	2500 5,500	7280 23'10"
-3000 mm -10'0"	kg lb	*8700 *19,450	*8700 *19,450	*11,400 *24,650	8750 18,850	*7750 *16,700	4800 10,250	5250 11,250	3250 7,000			4800 10,650	3000 6,650	6400 20'10"
-4500 mm -15'0"	kg lb			*9100 19,350	9000 19,350	*6150 *12,950	4900 10,600					*5450 *12,000	4400 9,900	4920 15'9"

Reach Boom Lift Capacities – Counterweight: 3.57 mt (7,870 lb) – without Bucket

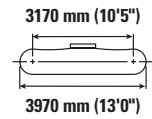
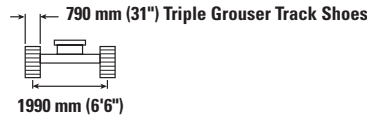
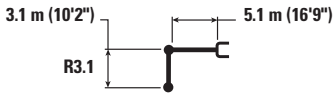

		1500 mm/5'0"		3000 mm/10'0"		4500 mm/15'0"		6000 mm/20'0"		7500 mm/25'0"		mm ft/in		
7500 mm 25'0"	kg lb											*2700 *6,050	*2700 *6,050	5380 17'2"
6000 mm 20'0"	kg lb							*3650 *7,550	*3650 *7,550			*2450 *5,400	*2450 *5,400	6670 21'7"
4500 mm 15'0"	kg lb							*3900 *8,500	3800 8,200			*2400 *5,250	*2400 *5,250	7440 24'3"
3000 mm 10'0"	kg lb			*7500 *15,950	*7500 *15,950	*5300 *11,450	*5300 *11,450	*4500 *9,700	3650 7,900	*3600 *7,100	2600 5,600	*2450 *5,400	2450 5,350	7850 25'8"
1500 mm 5'0"	kg lb			*8250 *19,750	*8250 *19,750	*6750 *14,550	5250 11,250	*5150 *11,200	3500 7,550	4000 8,600	2550 5,450	*2650 *5,800	2350 5,100	7960 26'1"
0 mm 0'0"	kg lb			*7150 *16,450	*7150 *16,450	*7750 *16,800	4950 10,700	5400 11,650	3350 7,250	3950 *8,350	2500 5,350	*3000 *6,550	2350 5,200	7780 25'5"
-1500 mm -5'0"	kg lb	*5400 *12,050	*5400 *12,050	*9700 *22,100	8850 19,000	*8100 *17,550	4850 10,450	5350 11,450	3300 7,100			*3600 *7,950	2550 5,650	7280 23'10"
-3000 mm -10'0"	kg lb	*8700 *19,450	*8700 *19,450	*11,400 *24,650	8950 19,200	*7750 *16,700	4850 10,450	5350 11,500	3300 7,150			4900 10,850	3050 6,750	6400 20'10"
-4500 mm -15'0"	kg lb			*9100 *19,350	*9100 *19,350	*6150 *12,950	5000 10,800					*5450 *12,000	4450 10,100	4920 15'9"



ISO 10567



* Indicates that the load is limited by hydraulic lifting capacity rather than tipping load. The above loads are in compliance with hydraulic excavator lift capacity standard ISO 10567:2007. They do not exceed 87% of hydraulic lifting capacity or 75% of tipping load. Weight of all lifting accessories must be deducted from the above lifting capacities. Lifting capacities are based on the machine standing on a firm, uniform supporting surface. The use of a work tool attachment point to handle/lift objects, could affect the machine lift performance.

Lift capacity stays with ±5% for all available track shoes.

Always refer to the appropriate Operation and Maintenance Manual for specific product information.

317 Hydraulic Excavator Specifications

Variable Angle Boom Lift Capacities – Counterweight: 3.57 mt (7,870 lb) – without Bucket

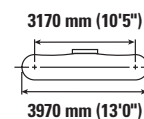
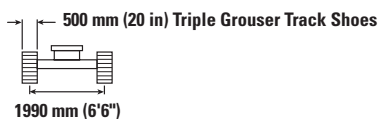
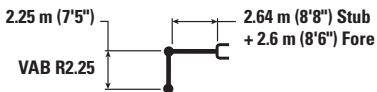

		3000 mm/10'0"		4500 mm/15'0"		6000 mm/20'0"				mm ft/in
7500 mm 25'0"	kg lb	*5950 *13,200	*5950 *13,200	*4000	*4000			*3900 *8,700	*3900 *8,700	4530 14'3"
6000 mm 20'0"	kg lb	*5400 *11,900	*5400 *11,900	*5550 *12,050	*5550 *12,050	*3300	*3300	*3300 *7,250	*3300 *7,250	6010 19'5"
4500 mm 15'0"	kg lb	*7800 *16,200	*7800 *16,200	*6000 *12,950	5500 11,850	*4600 *9,900	3550 7,600	*3100 *6,800	2850 6,250	6860 22'4"
3000 mm 10'0"	kg lb			*7250 *15,500	5100 11,050	*4900 *10,550	3400 7,300	*3100 *6,750	2500 5,550	7300 23'10"
1500 mm 5'0"	kg lb			8050 17,300	4750 10,250	5250 11,250	3250 6,950	*3250 *7,100	2400 5,250	7420 24'3"
0 mm 0'0"	kg lb			*7550 *16,400	4600 9,850	5100 11,000	3150 6,750	*3550 *7,800	2450 5,400	7220 23'8"
-1500 mm -5'0"	kg lb	*7100 *15,600	*7100 *15,600	*6150 *13,250	4550 9,800	*4450 *9,500	3100 6,700	*3400 *7,450	2750 6,050	6680 21'10"

Variable Angle Boom Lift Capacities – Counterweight: 3.57 mt (7,870 lb) – without Bucket

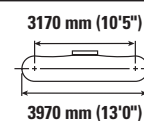
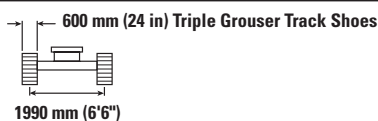
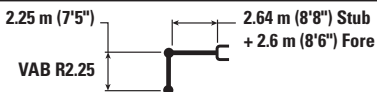

		3000 mm/10'0"		4500 mm/15'0"		6000 mm/20'0"				mm ft/in
7500 mm 25'0"	kg lb	*5950 *13,200	*5950 *13,200	*4000	*4000			*3900 *8,700	*3900 *8,700	4530 14'3"
6000 mm 20'0"	kg lb	*5400 *11,900	*5400 *11,900	*5550 *12,050	*5550 *12,050	*3300	*3300	*3300 *7,250	*3300 *7,250	6010 19'5"
4500 mm 15'0"	kg lb	*7800 *16,200	*7800 *16,200	*6000 *12,950	5550 11,950	*4600 *9,900	3550 7,650	*3100 *6,800	2850 6,350	6860 22'4"
3000 mm 10'0"	kg lb			*7250 *15,500	5150 11,150	*4900 *10,550	3450 7,350	*3100 *6,750	2550 5,600	7300 23'10"
1500 mm 5'0"	kg lb			*8100 17,500	4800 10,400	5300 11,350	3250 7,050	*3250 *7,100	2450 5,350	7420 24'3"
0 mm 0'0"	kg lb			*7550 *16,400	4650 10,000	5150 11,100	3150 6,800	*3550 *7,800	2500 5,450	7220 23'8"
-1500 mm -5'0"	kg lb	*7100 *15,600	*7100 *15,600	*6150 *13,250	4600 9,950	*4450 *9,500	3150 6,800	*3400 *7,450	2750 6,100	6680 21'10"



ISO 10567



* Indicates that the load is limited by hydraulic lifting capacity rather than tipping load. The above loads are in compliance with hydraulic excavator lift capacity standard ISO 10567:2007. They do not exceed 87% of hydraulic lifting capacity or 75% of tipping load. Weight of all lifting accessories must be deducted from the above lifting capacities. Lifting capacities are based on the machine standing on a firm, uniform supporting surface. The use of a work tool attachment point to handle/lift objects, could affect the machine lift performance.

Lift capacity stays with ±5% for all available track shoes.

Always refer to the appropriate Operation and Maintenance Manual for specific product information.

Maximum length of VAB.

317 Hydraulic Excavator Specifications

Variable Angle Boom Lift Capacities – Counterweight: 3.57 mt (7,870 lb) – without Bucket

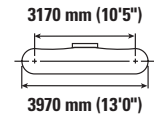
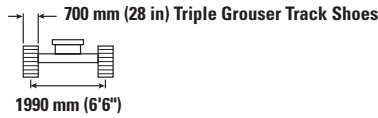
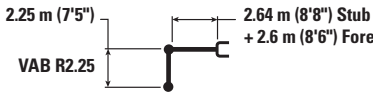

Boom Length	Unit	3000 mm/10'0"		4500 mm/15'0"		6000 mm/20'0"		3170 mm (10'5") 3970 mm (13'0")		mm ft/in
7500 mm 25'0"	kg lb	*5950 *13,200	*5950 *13,200	*4000	*4000			*3900 *8,700	*3900 *8,700	4530 14'3"
6000 mm 20'0"	kg lb	*5400 *11,900	*5400 *11,900	*5550 *12,050	*5550 *12,050	*3300	*3300	*3300 *7,250	*3300 *7,250	6010 19'5"
4500 mm 15'0"	kg lb	*7800 *16,200	*7800 *16,200	*6000 *12,950	5600 12,050	*4600 *9,900	3600 7,750	*3100 *6,800	2900 6,400	6860 22'4"
3000 mm 10'0"	kg lb			*7250 *15,500	5250 11,250	*4900 *10,550	3450 7,450	*3100 *6,750	2550 5,650	7300 23'10"
1500 mm 5'0"	kg lb			*8100 *17,600	4900 10,500	5350 11,500	3300 7,100	*3250 *7,100	2450 5,400	7420 24'3"
0 mm 0'0"	kg lb			*7550 *16,400	4700 10,100	5250 11,250	3200 6,900	*3550 *7,800	2500 5,550	7220 23'8"
-1500 mm -5'0"	kg lb	*7100 *15,600	*7100 *15,600	*6150 *13,250	4700 10,050	*4450 *9,500	3200 6,850	*3400 *7,450	2800 6,150	6680 21'10"

Variable Angle Boom Lift Capacities – Counterweight: 3.57 mt (7,870 lb) – without Bucket

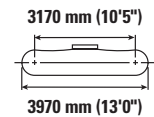
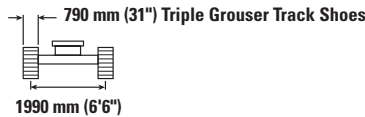
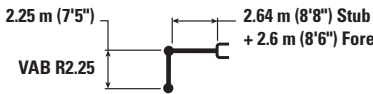

Boom Length	Unit	3000 mm/10'0"		4500 mm/15'0"		6000 mm/20'0"		3170 mm (10'5") 3970 mm (13'0")		mm ft/in
7500 mm 25'0"	kg lb	*5950 *13,200	*5950 *13,200	*4000	*4000			*3900 *8,700	*3900 *8,700	4530 14'3"
6000 mm 20'0"	kg lb	*5400 *11,900	*5400 *11,900	*5550 *12,050	*5550 *12,050	*3300	*3300	*3300 *7,250	*3300 *7,250	6010 19'5"
4500 mm 15'0"	kg lb	*7800 *16,200	*7800 *16,200	*6000 *12,950	5700 12,250	*4600 *9,900	3650 7,900	*3100 *6,800	2950 6,550	6860 22'4"
3000 mm 10'0"	kg lb			*7250 *15,500	5300 11,450	*4900 *10,550	3550 7,600	*3100 *6,750	2650 5,750	7300 23'10"
1500 mm 5'0"	kg lb			*8100 *17,600	4950 10,700	*5400 *11,550	3350 7,250	*3250 *7,100	2500 5,500	7420 24'3"
0 mm 0'0"	kg lb			*7550 *16,400	4800 10,300	5350 11,500	3250 7,050	*3550 *7,800	2600 5,650	7220 23'8"
-1500 mm -5'0"	kg lb	*7100 *15,600	*7100 *15,600	*6150 *13,250	4750 10,250	*4450 *9,500	3250 7,000	*3400 *7,450	2850 6,300	6680 21'10"



ISO 10567



* Indicates that the load is limited by hydraulic lifting capacity rather than tipping load. The above loads are in compliance with hydraulic excavator lift capacity standard ISO 10567:2007. They do not exceed 87% of hydraulic lifting capacity or 75% of tipping load. Weight of all lifting accessories must be deducted from the above lifting capacities. Lifting capacities are based on the machine standing on a firm, uniform supporting surface. The use of a work tool attachment point to handle/lift objects, could affect the machine lift performance.

Lift capacity stays with ±5% for all available track shoes.

Always refer to the appropriate Operation and Maintenance Manual for specific product information.

Maximum length of VAB.

317 Hydraulic Excavator Specifications

Variable Angle Boom Lift Capacities – Counterweight: 3.57 mt (7,870 lb) – without Bucket

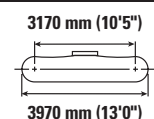
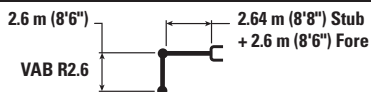

		1500 mm/5'0"		3000 mm/10'0"		4500 mm/15'0"		6000 mm/20'0"		7500 mm/25'0"		mm ft/in		
9000 mm 30'0"	kg lb	*13,600	*13,600									*5100 *12,900	*5100 *12,900	2250 5'5"
7500 mm 25'0"	kg lb			*5050 *11,250	*5050 *11,250	*4500 *9,300	*4500 *9,300					*3200 *7,100	*3200 *7,100	5050 16'1"
6000 mm 20'0"	kg lb			*4500 *9,950	*4500 *9,950	*4950 *10,850	*4950 *10,850	*4100 *8,250	3650 7,750			*2750 *6,050	*2750 *6,050	6410 20'9"
4500 mm 15'0"	kg lb			*5600 *11,950	*5600 *11,950	*5700 *12,300	5550 12,000	*4400 *9,500	3550 7,650			*2600 *5,750	*2600 *5,750	7210 23'6"
3000 mm 10'0"	kg lb					*6850 *14,600	5200 11,150	*4750 *10,150	3400 7,350	*3450 *5,750	2400 5,150	*2600 *5,700	2350 5,150	7640 25'0"
1500 mm 5'0"	kg lb					*8100 17,400	4800 10,350	*5200 *11,150	3250 6,950	3750 *8,000	2350 5,050	*2750 *5,950	2250 4,950	7750 25'4"
0 mm 0'0"	kg lb					*7750 *16,800	4600 9,850	5100 10,950	3100 6,700	*3500	2300	*3000 *6,550	2300 5,050	7560 24'9"
-1500 mm -5'0"	kg lb			*8200 *17,850	*8200 17,850	*6550 *14,100	4500 9,750	*4800 *10,250	3100 6,600			*3400 *7,400	2500 5,550	7050 23'0"

Variable Angle Boom Lift Capacities – Counterweight: 3.57 mt (7,870 lb) – without Bucket

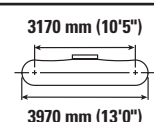
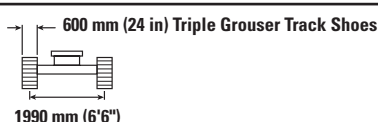
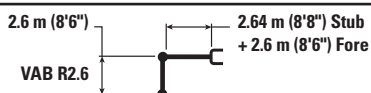

		1500 mm/5'0"		3000 mm/10'0"		4500 mm/15'0"		6000 mm/20'0"		7500 mm/25'0"		mm ft/in		
9000 mm 30'0"	kg lb	*13,600	*13,600									*5100 *12,900	*5100 *12,900	2250 5'5"
7500 mm 25'0"	kg lb			*5050 *11,250	*5050 *11,250	*4500 *9,300	*4500 *9,300					*3200 *7,100	*3200 *7,100	5050 16'1"
6000 mm 20'0"	kg lb			*4500 *9,950	*4500 *9,950	*4950 *10,850	*4950 *10,850	*4100 *8,250	3650 7,800			*2750 *6,050	*2750 *6,050	6410 20'9"
4500 mm 15'0"	kg lb			*5600 *11,950	*5600 *11,950	*5700 *12,300	5600 12,100	*4400 *9,500	3600 7,750			*2600 *5,750	*2600 *5,750	7210 23'6"
3000 mm 10'0"	kg lb					*6850 *14,600	5250 11,300	*4750 *10,150	3450 7,400	*3450 *5,750	2450 5,250	*2600 *5,700	2400 5,200	7640 25'0"
1500 mm 5'0"	kg lb					*8100 *17,450	4850 10,450	*5200 *11,150	3300 7,050	3800 *8,000	2400 5,100	*2750 *5,950	2300 5,000	7750 25'4"
0 mm 0'0"	kg lb					*7750 *16,800	4650 9,950	5150 11,100	3150 6,800	*3500	2350	*3000 *6,550	2300 5,100	7560 24'9"
-1500 mm -5'0"	kg lb			*8200 *17,850	*8200 17,850	*6550 *14,100	4600 9,850	*4800 *10,250	3100 6,700			*3400 *7,400	2550 5,600	7050 23'0"



ISO 10567



* Indicates that the load is limited by hydraulic lifting capacity rather than tipping load. The above loads are in compliance with hydraulic excavator lift capacity standard ISO 10567:2007. They do not exceed 87% of hydraulic lifting capacity or 75% of tipping load. Weight of all lifting accessories must be deducted from the above lifting capacities. Lifting capacities are based on the machine standing on a firm, uniform supporting surface. The use of a work tool attachment point to handle/lift objects, could affect the machine lift performance.

Lift capacity stays with ±5% for all available track shoes.

Always refer to the appropriate Operation and Maintenance Manual for specific product information.

Maximum length of VAB.

317 Hydraulic Excavator Specifications

Variable Angle Boom Lift Capacities – Counterweight: 3.57 mt (7,870 lb) – without Bucket

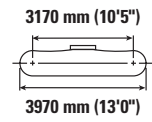
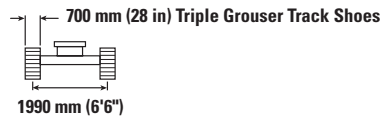
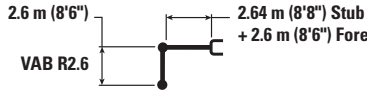

Boom Length	Unit	1500 mm/5'0"		3000 mm/10'0"		4500 mm/15'0"		6000 mm/20'0"		7500 mm/25'0"		mm ft/in		
		kg	lb	kg	lb	kg	lb	kg	lb	kg	lb	kg	lb	
9000 mm 30'0"	kg lb	*13,600	*13,600									*5100 *12,900	*5100 *12,900	2250 5'5"
7500 mm 25'0"	kg lb			*5050 *11,250	*5050 *11,250	*4500 *9,300	*4500 *9,300					*3200 *7,100	*3200 *7,100	5050 16'1"
6000 mm 20'0"	kg lb			*4500 *9,950	*4500 *9,950	*4950 *10,850	*4950 *10,850	*4100 *8,250	3700 7,900			*2750 *6,050	*2750 *6,050	6410 20'9"
4500 mm 15'0"	kg lb			*5600 *11,950	*5600 *11,950	*5700 *12,300	5700 12,200	*4400 *9,500	3650 7,800			*2600 *5,750	*2600 *5,750	7210 23'6"
3000 mm 10'0"	kg lb					*6850 *14,600	5300 11,400	*4750 *10,150	3500 7,500	*3450 *5,750	2500 5,300	*2600 *5,700	2400 5,300	7640 25'0"
1500 mm 5'0"	kg lb					*8100 *17,450	4900 10,600	*5200 *11,150	3300 7,100	*3850 *8,000	2400 5,150	*2750 *5,950	2300 5,050	7750 25'4"
0 mm 0'0"	kg lb					*7750 *16,800	4700 10,100	5200 11,250	3200 6,850	*3500	2350	*3000 *6,550	2350 5,150	7560 24'9"
-1500 mm -5'0"	kg lb			*8200 *17,850	*8200 *17,850	*6550 *14,100	4650 9,950	*4800 *10,250	3150 6,800			*3400 *7,400	2600 5,700	7050 23'0"

Variable Angle Boom Lift Capacities – Counterweight: 3.57 mt (7,870 lb) – without Bucket

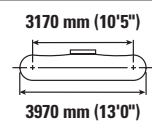
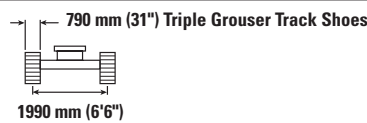
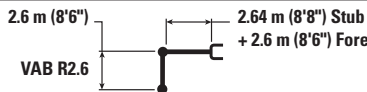

Boom Length	Unit	1500 mm/5'0"		3000 mm/10'0"		4500 mm/15'0"		6000 mm/20'0"		7500 mm/25'0"		mm ft/in		
		kg	lb	kg	lb	kg	lb	kg	lb	kg	lb	kg	lb	
9000 mm 30'0"	kg lb	*13,600	*13,600									*5100 *12,900	*5100 *12,900	2250 5'5"
7500 mm 25'0"	kg lb			*5050 *11,250	*5050 *11,250	*4500 *9,300	*4500 *9,300					*3200 *7,100	*3200 *7,100	5050 16'1"
6000 mm 20'0"	kg lb			*4500 *9,950	*4500 *9,950	*4950 *10,850	*4950 *10,850	*4100 *8,250	3750 8,050			*2750 *6,050	*2750 *6,050	6410 20'9"
4500 mm 15'0"	kg lb			*5600 *11,950	*5600 *11,950	*5700 *12,300	*5700 *12,300	*4400 *9,500	3700 7,950			*2600 *5,750	*2600 *5,750	7210 23'6"
3000 mm 10'0"	kg lb					*6850 *14,600	5400 11,600	*4750 *10,150	3550 7,650	*3450 *5,750	2550 5,400	*2600 *5,700	2450 5,400	7640 25'0"
1500 mm 5'0"	kg lb					*8100 *17,450	5000 10,800	*5200 *11,150	3400 7,250	*3850 *8,000	2450 5,300	*2750 *5,950	2350 5,150	7750 25'4"
0 mm 0'0"	kg lb					*7750 *16,800	4800 10,300	5350 11,450	3250 7,000	*3500	2400	*3000 *6,550	2400 5,250	7560 24'9"
-1500 mm -5'0"	kg lb			*8200 *17,850	*8200 *17,850	*6550 *14,100	4750 10,150	*4800 *10,250	3200 6,900			*3400 *7,400	2650 5,800	7050 23'0"



ISO 10567



* Indicates that the load is limited by hydraulic lifting capacity rather than tipping load. The above loads are in compliance with hydraulic excavator lift capacity standard ISO 10567:2007. They do not exceed 87% of hydraulic lifting capacity or 75% of tipping load. Weight of all lifting accessories must be deducted from the above lifting capacities. Lifting capacities are based on the machine standing on a firm, uniform supporting surface. The use of a work tool attachment point to handle/lift objects, could affect the machine lift performance.

Lift capacity stays with ±5% for all available track shoes.

Always refer to the appropriate Operation and Maintenance Manual for specific product information.

Maximum length of VAB.

317 Hydraulic Excavator Specifications

Bucket Specifications and Compatibility – Europe

	Linkage	Width		Capacity		Weight		Fill	Reach Boom		Variable Angle Boom	
		mm	in	m ³	yd ³	kg	lb		%	R2.6 (8'6")	R3.1 (10'2")	R2.25 (7'5")
Pin-On (No Quick Coupler)												
General Duty	316	600	24	0.35	0.46	440	969	100	●	●	●	●
	316	900	36	0.62	0.81	546	1,203	100	●	●	●	●
	316	1200	48	0.91	1.19	658	1,450	100	●	⊙	⊙	⊙
	316	1300	51	1.00	1.31	695	1,532	100	⊙	⊖	⊙	⊖
Ditch Cleaning	316	2000	78	0.94	1.23	723	1,594	100	⊙	⊖	⊙	⊖
Ditch Cleaning – Tilt	316	2000	79	0.86	1.12	1028	2,266	100	⊙	⊖	⊖	⊖
Maximum load with pin-on (payload + bucket)								kg	2510	2290	2450	2260
								lb	5,523	5,053	5,394	4,975
With Cat Pin Grabber Coupler												
General Duty	316	600	24	0.35	0.46	440	969	100	●	●	●	●
	316	900	36	0.62	0.81	546	1,203	100	●	●	●	●
	316	1200	48	0.91	1.19	658	1,450	100	⊙	⊖	⊙	⊖
	316	1300	51	1.00	1.31	695	1,532	100	⊖	○	⊖	○
Ditch Cleaning	316	2000	78	0.94	1.23	723	1,594	100	⊖	⊖	⊖	○
Ditch Cleaning – Tilt	316	2000	79	0.86	1.12	1028	2,266	100	⊖	○	○	○
Maximum load with coupler (payload + bucket)								kg	2305	2092	2247	2057
								lb	5,082	4,613	4,954	4,534

The above loads are in compliance with hydraulic excavator standard EN474-5:2006+A3:2013, they do not exceed 87% of hydraulic lifting capacity or 75% of tipping capacity with front linkage fully extended at ground line with bucket curled.
Capacity based on ISO 7451:2007.

Maximum Material Density:

- 2100 kg/m³ (3,500 lb/yd³)
- ⊙ 1800 kg/m³ (3,000 lb/yd³)
- ⊖ 1500 kg/m³ (2,500 lb/yd³)
- 1200 kg/m³ (2,000 lb/yd³)

Caterpillar recommends using appropriate work tools to maximize the value customers receive from our products. Use of work tools, including buckets, which are outside of Caterpillar's recommendations or specifications for weight, dimensions, flows, pressures, etc. may result in less-than-optimal performance, including but not limited to reductions in production, stability, reliability, and component durability. Improper use of a work tool resulting in sweeping, prying, twisting and/or catching of heavy loads will reduce the life of the boom and stick.

(continued on next page)

317 Hydraulic Excavator Specifications

Bucket Specifications and Compatibility – Europe (continued)

	Linkage	Width		Capacity		Weight		Fill	Reach Boom		Variable Angle Boom	
		mm	in	m ³	yd ³	kg	lb		%	R2.6 (8'6")	R3.1 (10'2")	R2.25 (7'5")
With CW30 Coupler												
General Duty	316	600	24	0.35	0.46	439	967	100	●	●	●	●
	316	750	30	0.49	0.64	475	1,047	100	●	●	●	●
	316	900	36	0.62	0.81	534	1,177	100	●	●	●	●
	316	1100	43	0.80	1.04	593	1,307	100	●	⊙	●	⊙
	316	1200	48	0.90	1.18	646	1,423	100	⊙	⊖	⊙	⊖
	316	1300	51	1.00	1.31	677	1,492	100	⊖	○	⊖	○
Heavy Duty	316	1300	51	1.00	1.31	694	1,529	100	⊖	○	⊖	○
General Duty – Leveling Edge	316	996	39.2	0.70	0.93	586	1,291	100	●	●	●	●
	316	1200	47	0.91	1.19	672	1,481	100	⊙	⊖	⊙	⊖
	316	690	27	0.47	0.61	476	1,049	100	●	●	●	●
	316	790	31	0.56	0.73	509	1,122	100	●	●	●	●
Ditch Cleaning	316	1400	55	1.09	1.43	738	1,626	100	○	○	○	○
	316	1800	72	1.10	1.44	646	1,423	100	⊖	○	⊖	○
	316	1800	72	1.24	1.62	678	1,496	100	○	◇	○	◇
Ditch Cleaning – Tilt	316	2100	82	1.45	1.90	760	1,675	100	◇	◇	◇	◇
	316	1800	72	0.78	1.02	1048	2,310	100	⊖	○	⊖	○
	316	2000	79	0.86	1.13	1111	2,449	100	○	◇	○	◇
	Maximum load with coupler (payload + bucket)								kg	2287	2074	2229
								lb	5,042	4,572	4,913	4,494
With CW30S Coupler												
General Duty	316	600	24	0.35	0.46	423	932	100	●	●	●	●
	316	750	30	0.49	0.64	471	1,038	100	●	●	●	●
	316	900	36	0.62	0.81	534	1,177	100	●	●	●	●
	316	1100	43	0.80	1.04	593	1,307	100	●	⊙	●	⊙
	316	1200	48	0.91	1.18	646	1,423	100	⊙	⊖	⊙	⊖
	316	1300	51	1.00	1.31	677	1,492	100	⊖	⊖	⊖	○
	316	1400	55	1.09	1.43	707	1,558	100	⊖	○	⊖	○
Heavy Duty	316	1200	48	0.91	1.18	663	1,461	100	⊙	⊖	⊙	⊖
	316	1300	51	1.00	1.31	695	1,531	100	⊖	○	⊖	○
Ditch Cleaning – Tilt	316	2000	79	0.86	1.13	1092	2,407	100	⊖	○	○	○
Maximum load with coupler (payload + bucket)								kg	2322	2109	2264	2073
								lb	5,119	4,650	4,991	4,571

The above loads are in compliance with hydraulic excavator standard EN474-5:2006+A3:2013, they do not exceed 87% of hydraulic lifting capacity or 75% of tipping capacity with front linkage fully extended at ground line with bucket curled.

Capacity based on ISO 7451:2007.

Maximum Material Density:

- 2100 kg/m³ (3,500 lb/yd³)
- ⊙ 1800 kg/m³ (3,000 lb/yd³)
- ⊖ 1500 kg/m³ (2,500 lb/yd³)
- 1200 kg/m³ (2,000 lb/yd³)
- ◇ 900 kg/m³ (1,500 lb/yd³)

Caterpillar recommends using appropriate work tools to maximize the value customers receive from our products. Use of work tools, including buckets, which are outside of Caterpillar's recommendations or specifications for weight, dimensions, flows, pressures, etc. may result in less-than-optimal performance, including but not limited to reductions in production, stability, reliability, and component durability. Improper use of a work tool resulting in sweeping, prying, twisting and/or catching of heavy loads will reduce the life of the boom and stick.

(continued on next page)

317 Hydraulic Excavator Specifications

Bucket Specifications and Compatibility – Europe (continued)

	Linkage	Width		Capacity		Weight		Fill	Reach Boom		Variable Angle Boom	
		mm	in	m ³	yd ³	kg	lb		%	R2.6 (8'6")	R3.1 (10'2")	R2.25 (7'5")
Pin-On, TRS14 CW30												
Grading – General Duty	316	1700	67	0.65	0.85	634	1,397	100	⊙	⊖	⊖	○
Trenching – General Duty	316	660	26	0.45	0.59	395	871	100	●	●	●	●
Maximum load with pin-on (payload + bucket)								kg	1783	1570	1725	1534
								lb	3,931	3,461	3,802	3,383
Pin-On, TRS14 CW30S												
Grading – General Duty	316	1600	63	0.75	0.98	595	1,311	100	⊖	○	⊖	○
Maximum load with pin-on (payload + bucket)								kg	1829	1616	1771	1580
								lb	4,032	3,563	3,904	3,484
Pin-On, TRS14 S60												
Grading – General Duty	316	1600	63	0.75	0.98	576	1,270	100	⊙	⊖	⊙	⊖
	316	1700	67	0.80	1.05	610	1,346	100	⊖	○	⊖	○
	316	1800	71	0.90	1.18	643	1,418	100	⊖	○	○	○
Trenching – General Duty	316	1800	71	0.33	0.43	540	1,190	100	●	●	●	●
Maximum load with pin-on (payload + bucket)								kg	1930	1717	1872	1681
								lb	4,255	3,785	4,126	3,707
CW30, TRS14 CW30												
Grading – General Duty	316	1700	67	0.65	0.85	634	1,397	100	○	◇	○	◇
	316	660	26	0.45	0.59	395	871	100	●	●	●	●
Maximum load with coupler (payload + bucket)								kg	1551	1338	1493	1302
								lb	3,420	2,950	3,291	2,871
CW30S, TRS14 CW30S												
Grading – General Duty	316	1600	63	0.75	0.98	595	1,311	100	○	◇	○	◇
Maximum load with coupler (payload + bucket)								kg	1632	1419	1574	1383
								lb	3,598	3,128	3,469	3,050
S60, TRS10 S60												
Grading – General Duty	316	1600	63	0.75	0.98	576	1,270	100	⊖	○	⊖	○
	316	1700	67	0.80	1.05	610	1,346	100	⊖	○	○	○
	316	1800	71	0.90	1.18	643	1,418	100	○	◇	○	◇
	316	1800	71	0.33	0.43	540	1,190	100	●	●	●	●
Maximum load with coupler (payload + bucket)								kg	1789	1576	1731	1540
								lb	3,944	3,474	3,816	3,396

The above loads are in compliance with hydraulic excavator standard EN474-5:2006+A3:2013, they do not exceed 87% of hydraulic lifting capacity or 75% of tipping capacity with front linkage fully extended at ground line with bucket curled.
Capacity based on ISO 7451:2007.

Maximum Material Density:

- 2100 kg/m³ (3,500 lb/yd³)
- ⊙ 1800 kg/m³ (3,000 lb/yd³)
- ⊖ 1500 kg/m³ (2,500 lb/yd³)
- 1200 kg/m³ (2,000 lb/yd³)
- ◇ 900 kg/m³ (1,500 lb/yd³)

Caterpillar recommends using appropriate work tools to maximize the value customers receive from our products. Use of work tools, including buckets, which are outside of Caterpillar's recommendations or specifications for weight, dimensions, flows, pressures, etc. may result in less-than-optimal performance, including but not limited to reductions in production, stability, reliability, and component durability. Improper use of a work tool resulting in sweeping, prying, twisting and/or catching of heavy loads will reduce the life of the boom and stick.

317 Hydraulic Excavator Specifications

Bucket Specifications and Compatibility – Australia and New Zealand

	Linkage	Width		Capacity		Weight		Fill	Reach Boom	
		mm	in	m ³	yd ³	kg	lb		%	R2.6 (8'6")
Pin-On (No Quick Coupler)										
General Duty	316	600	24	0.35	0.46	440	969	100	●	●
	316	900	36	0.62	0.81	546	1,203	100	●	●
	316	1200	48	0.91	1.19	658	1,450	100	●	⊙
Clean Up	316	1500	60	1.24	1.62	770	1,698	100	○	○
	316	1800	72	1.53	2.00	911	2,008	100	◇	◇
Ditch Cleaning – Tilt	316	1800	72	0.78	1.02	985	2,170	100	⊙	⊖
Maximum load with pin-on (payload + bucket)								kg	2510	2290
								lb	5,523	5,053
With Cat Pin Grabber Coupler										
General Duty	316	600	24	0.35	0.46	440	969	100	●	●
	316	900	36	0.62	0.81	546	1,203	100	●	●
	316	1200	48	0.91	1.19	658	1,450	100	⊙	⊖
Clean Up	316	1500	60	1.24	1.62	770	1,698	100	○	◇
	316	1800	72	1.53	2.00	911	2,008	100	◇	X
Ditch Cleaning – Tilt	316	1800	72	0.78	1.02	985	2,170	100	⊖	○
Maximum load with coupler (payload + bucket)								kg	2305	2092
								lb	5,082	4,613

The above loads are in compliance with hydraulic excavator standard EN474-5:2006+A3:2013, they do not exceed 87% of hydraulic lifting capacity or 75% of tipping capacity with front linkage fully extended at ground line with bucket curled.
Capacity based on ISO 7451:2007.

Maximum Material Density:

- 2100 kg/m³ (3,500 lb/yd³)
- ⊙ 1800 kg/m³ (3,000 lb/yd³)
- ⊖ 1500 kg/m³ (2,500 lb/yd³)
- 1200 kg/m³ (2,000 lb/yd³)
- ◇ 900 kg/m³ (1,500 lb/yd³)

Caterpillar recommends using appropriate work tools to maximize the value customers receive from our products. Use of work tools, including buckets, which are outside of Caterpillar's recommendations or specifications for weight, dimensions, flows, pressures, etc. may result in less-than-optimal performance, including but not limited to reductions in production, stability, reliability, and component durability. Improper use of a work tool resulting in sweeping, prying, twisting and/or catching of heavy loads will reduce the life of the boom and stick.

317 Hydraulic Excavator Specifications

Attachments Offering Guide – Europe

Not all Attachments are available in all regions. Consult your Cat dealer for configurations available in your region.

<input checked="" type="checkbox"/> Match	<input type="checkbox"/> No Match	<input checked="" type="checkbox"/> 1800 kg/m ³ (3,000 lb/yd ³)	<input type="checkbox"/> 1200 kg/m ³ (2,000 lb/yd ³)	<input type="checkbox"/> XXXX kg/m ³ (XXXX lb/yd ³)
---	-----------------------------------	---	--	---

PIN-ON ATTACHMENTS

Undercarriage		L			
Counterweight		3.57 mt (7,870 lb)			
Boom Type		Reach		VA	
Stick Length		2.60 m (8'6")	3.10 m (10'2")	2.25 m (7'5")	2.60 m (8'6")
Hydraulic Hammers	H110 S	✓	✓	✓	✓
	H115 GC S	✓	✓	✓	✓
	H115 S	✓	✓	✓	✓
	H120 S	✓	✓	✓	✓
Demolition and Sorting Grapples	G313 GC	✓	✓	✓	✓
	G314	✓	✓	✓	✓
	G317 GC	✓	✓	✓	✓
Mobile Scrap and Demolition Shears	S3015 Flat Top	✓	✓	✓	✓
Pulverizers	P214 Secondary Pulverizer	✓	✓	✓	✓
Compactors (Vibratory Plate)	CVP75	✓	✓	✓	✓
Orange Peel Grapples	GSH420-500	●	●	●	●
	GSH420-600	●	○	●	○
	GSH420-750	○	○	○	○
	GSH520-500	●	○	●	○
	GSH520-600	○	○	○	○
	GSH520-750	○		○	
	GSV420-400	●	●	●	●
	GSV420-500	●	●	●	●
	GSV420-600	●	●	●	●
	GSV420-750	○	○	○	○
	GSV420-1250	◇	◇	◇	◇
	GSV520 GC-400	●	●	●	●
	GSV520 GC-500	●	●	●	●
	GSV520 GC-600	●	○	●	○
	GSV520 GC-750	○	○	○	○
	GSV520-400	●	●	●	●
	GSV520-500	●	●	●	●
	GSV520-600	●	○	●	○
	GSV520-750	○		○	

(continued on next page)

317 Hydraulic Excavator Specifications

Attachments Offering Guide – Europe (continued)

Not all Attachments are available in all regions. Consult your Cat dealer for configurations available in your region.

Match

* Working range front only

No Match

CAT PIN GRABBER COUPLER ATTACHMENTS

Undercarriage		L			
Counterweight		3.57 mt (7,870 lb)			
Boom Type		Reach		VA	
Stick Length		2.60 m (8'6")	3.10 m (10'2")	2.25 m (7'5")	2.60 m (8'6")
Hydraulic Hammers	H110 S	✓	✓	✓	✓
	H115 GC S	✓	✓	✓	✓
	H115 S	✓	✓	✓	✓
	H120 S	✓	✓	✓	✓
Demolition and Sorting Grapples	G313 GC	✓	✓	✓	✓
	G314	✓	✓	✓	✓
	G317 GC	✓*			
Mobile Scrap and Demolition Shears	S3015 Flat Top	✓	✓	✓	✓
Pulverizers	P214 Secondary Pulverizer	✓	✓		
Compactors (Vibratory Plate)	CVP75	✓	✓	✓	✓

CW-30s DEDICATED COUPLER ATTACHMENTS

Undercarriage		L			
Counterweight		3.57 mt (7,870 lb)			
Boom Type		Reach		VA	
Stick Length		2.60 m (8'6")	3.10 m (10'2")	2.25 m (7'5")	2.60 m (8'6")
Hydraulic Hammers	H110 S	✓	✓	✓	✓
	H115 GC S	✓	✓	✓	✓
	H115 S	✓	✓	✓	✓
	H120 S	✓	✓		
Demolition and Sorting Grapples	G313 GC	✓	✓	✓	✓
	G314	✓	✓	✓	✓
	G317 GC	✓	✓*		
Mobile Scrap and Demolition Shears	S3015 Flat Top	✓	✓	✓	✓
Pulverizers	P214 Secondary Pulverizer	✓	✓		
Compactors (Vibratory Plate)	CVP75	✓	✓	✓	✓

(continued on next page)

317 Hydraulic Excavator Specifications

Attachments Offering Guide – Europe (continued)

Not all Attachments are available in all regions. Consult your Cat dealer for configurations available in your region.

Match * Working range front only No Match

CW-30 DEDICATED COUPLER ATTACHMENTS

Undercarriage		L			
Counterweight		3.57 mt (7,870 lb)			
Boom Type		Reach		VA	
Stick Length		2.60 m (8'6")	3.10 m (10'2")	2.25 m (7'5")	2.60 m (8'6")
Hydraulic Hammers	H110 S	✓	✓	✓	✓
	H115 GC S	✓	✓	✓	✓
	H115 S	✓	✓	✓	✓
	H120 S	✓	✓		
Demolition and Sorting Grapples	G313 GC	✓	✓	✓	✓
	G313 GC fixed CAN	✓	✓	✓	✓
	G314	✓	✓	✓	✓
	G317 GC	✓	✓*	✓	✓*
	G317 GC fixed CAN	✓	✓		
Mobile Scrap and Demolition Shears	S3015 Flat Top	✓	✓	✓	✓
Pulverizers	P214 Secondary Pulverizer	✓	✓	✓	✓
Compactors (Vibratory Plate)	CVP75	✓	✓	✓	✓

S60 DEDICATED COUPLER ATTACHMENTS

Undercarriage		L			
Counterweight		3.57 mt (7,870 lb)			
Boom Type		Reach		VA	
Stick Length		2.60 m (8'6")	3.10 m (10'2")	2.25 m (7'5")	2.60 m (8'6")
Hydraulic Hammers	H110 S	✓	✓	✓	✓
	H115 GC S	✓	✓	✓	✓
	H115 S	✓	✓	✓	✓
	H120 S	✓	✓		
Demolition and Sorting Grapples	G313 GC	✓	✓	✓	✓
	G314	✓	✓	✓	✓
	G317 GC	✓	✓*		
Mobile Scrap and Demolition Shears	S3015 Flat Top	✓	✓	✓	✓
Pulverizers	P214 Secondary Pulverizer	✓	✓		
Compactors (Vibratory Plate)	CVP75	✓	✓	✓	✓

(continued on next page)

317 Hydraulic Excavator Specifications

Attachments Offering Guide – Europe (continued)

Not all Attachments are available in all regions. Consult your Cat dealer for configurations available in your region.

Match * Working range front only No Match

HCS60 DEDICATED COUPLER ATTACHMENTS

Undercarriage		L			
Counterweight		3.57 mt (7,870 lb)			
Boom Type		Reach		VA	
Stick Length		2.60 m (8'6")	3.10 m (10'2")	2.25 m (7'5")	2.60 m (8'6")
Hydraulic Hammers	H110 S	✓	✓	✓	✓
	H115 S	✓	✓	✓	✓
	H120 S	✓	✓	✓	✓
Demolition and Sorting Grapples	G313 GC	✓	✓	✓	✓
	G314	✓	✓	✓	✓
	G317 GC	✓			
Mobile Scrap and Demolition Shears	S3015 Flat Top	✓	✓	✓	✓
Pulverizers	P214 Secondary Pulverizer	✓	✓		
Compactors (Vibratory Plate)	CVP75	✓	✓	✓	✓

HCS65 DEDICATED COUPLER ATTACHMENTS

Undercarriage		L			
Counterweight		3.57 mt (7,870 lb)			
Boom Type		Reach		VA	
Stick Length		2.60 m (8'6")	3.10 m (10'2")	2.25 m (7'5")	2.60 m (8'6")
Hydraulic Hammers	H110 S	✓	✓	✓	✓
	H115 S	✓	✓	✓	✓
	H120 S	✓	✓	✓	✓
Demolition and Sorting Grapples	G313 GC	✓	✓	✓	✓
	G314	✓	✓	✓	✓
	G317 GC	✓*			
Mobile Scrap and Demolition Shears	S3015 Flat Top	✓	✓	✓	✓
Pulverizers	P214 Secondary Pulverizer	✓	✓		
Compactors (Vibratory Plate)	CVP75	✓	✓	✓	✓

BOOM-MOUNT ATTACHMENTS

Undercarriage		L			
Counterweight		3.57 mt (7,870 lb)			
Boom Type		Reach		VA	
Mobile Scrap and Demolition Shears	S3035 Flat Top	✓			✓

317 Hydraulic Excavator Specifications

Attachments Offering Guide – Australia and New Zealand

Not all Attachments are available in all regions. Consult your Cat dealer for configurations available in your region.

Match

* Working range front only

PIN-ON ATTACHMENTS

Undercarriage		L	
Counterweight		3.57 mt (7,870 lb)	
Boom Type		Reach	
Stick Length		2.60 m (8'6")	3.10 m (10'2")
Hydraulic Hammers	H110 S	✓	✓
	H115 GC	✓	✓
	H115 GC S	✓	✓
	H115 S	✓	✓
	H120 S	✓	✓
Demolition and Sorting Grapples	G314	✓	✓
Mobile Scrap and Demolition Shears	S3015 Flat Top	✓	✓
Compactors (Vibratory Plate)	CVP75	✓	✓
Mulchers	HM3013	✓	✓
	HM4015	✓	✓
	HM4815	✓	✓

CAT PIN GRABBER COUPLER ATTACHMENTS

Undercarriage		L	
Counterweight		3.57 mt (7,870 lb)	
Boom Type		Reach	
Stick Length		2.60 m (8'6")	3.10 m (10'2")
Hydraulic Hammers	H110 S	✓	✓
	H115 GC	✓	✓
	H115 GC S	✓	✓
	H115 S	✓	✓
	H120 S	✓	✓
Demolition and Sorting Grapples	G314	✓	✓
Mobile Scrap and Demolition Shears	S3015 Flat Top	✓	✓
Compactors (Vibratory Plate)	CVP75	✓	✓
Mulchers	HM3013	✓	✓
	HM4015	✓	✓*
	HM4815	✓	✓*

BOOM-MOUNT ATTACHMENTS

Undercarriage		L	
Counterweight		3.57 mt (7,870 lb)	
Boom Type		Reach	
Mobile Scrap and Demolition Shears	S3035 Flat Top	✓	

317 Standard and Optional Equipment

Standard and Optional Equipment

Standard and optional equipment may vary. Consult your Cat dealer for details.

	Standard	Optional		Standard	Optional
BOOMS, STICKS AND LINKAGES			ELECTRICAL SYSTEM		
Variable Angle Boom (2.64 m [8'8"] Stub + 2.6 m [8'6"] Fore) ⁽¹⁾		✓	Maintenance free battery	✓	
5.1 m (16'9") Reach boom ⁽²⁾		✓	Centralized electrical disconnect switch	✓	
2.6 m (8'6") Reach stick		✓	Programmable time-delay LED working lights	✓	
3.1 m (10'2") Reach stick		✓	LED chassis light – 1,800 lumens	✓	
2.25 m (7'5") Reach stick ⁽¹⁾		✓	LED left-side and right-side VA boom lights – 1,800 lumens	✓	
Bucket linkage, without lifting eye, Cat Grade		✓	LED left-side one-piece boom light – 1,800 lumens	✓	
CAT TECHNOLOGY			LED right-side one-piece boom light – 1,800 lumens		✓
Cat Product Link™	✓		LED cab lights – 1,800 lumens		✓
Remote Flash	✓		360° lighting		✓
Remote Troubleshoot	✓		ENGINE		
Cat Grade Connectivity		✓	Cat® C4.4 single turbo diesel engine	✓	
– Compatibility with radios and base stations from Trimble, Topcon, and Leica	✓		Three selectable modes: Power, Smart, Eco	✓	
– Capability to install 3D grade systems from Trimble, Topcon, and Leica	✓		One-touch low idle with automatic engine speed control	✓	
Cat Grade with 2D and offset memory	✓		Auto engine idle shutdown	✓	
Cat Grade with Advanced 2D		✓	–18° C (–0° F) cold start capability ⁽³⁾	✓	
Cat Grade with 3D single GNSS		✓	–25° C (–13° F) cold start capability ⁽¹⁾	✓	
Cat Grade with 3D dual GNSS		✓	Two-stage fuel filtration system with water separator and indicator	✓	
Cat Assist:	✓		Sealed double element air filter with integrated precleaner	✓	
– Boom Assist			Electric fuel priming pump	✓	
– Bucket Assist			Electric cooling fans	✓	
– Swing Assist			*Requires PL161 attachment locator on work tool and Bluetooth® receiver on machine.		
– Grade Assist			⁽¹⁾ Europe only.		
– Lift Assist			⁽²⁾ Standard in Australia and New Zealand.		
Cat Payload:	✓		⁽³⁾ Australia and New Zealand only.		
– Static weigh			<i>(continued on next page)</i>		
– Semiautomatic calibration					
– Payload/cycle information					
– USB reporting capability					
2D E-Fence:	✓				
– E-ceiling					
– E-floor					
– E-swing					
– E-wall					
– E-cab avoidance					
Auto hammer stop	✓				
Laser catcher		✓			
Work tool recognition	✓				
Work tool tracking*	✓				

Standard and Optional Equipment *(continued)*

Standard and optional equipment may vary. Consult your Cat dealer for details.

	Standard	Optional		Standard	Optional
HYDRAULIC SYSTEM			SERVICE AND MAINTENANCE		
Electronic main control valve	✓		Side entry to service platform	✓	
Single type electronic main pump	✓		Grouped engine oil and fuel filters	✓	
Boom and stick regeneration circuits	✓		Ground level engine oil dipstick	✓	
Boom and stick drift reduction valve	✓		Scheduled Oil Sampling (S·O·S SM) sampling ports	✓	
Boom lowering check valve	✓		Integrated Vehicle Health Management system		✓
Stick lowering check valve (for Reach boom)	✓		UNDERCARRIAGE AND STRUCTURES		
Automatic hydraulic oil warm up	✓		500 mm (20") triple grouser track shoes		✓
Automatic two-speed travel	✓		600 mm (24") triple grouser track shoes		✓
Element type main hydraulic filter	✓		700 mm (28") triple grouser track shoes with additional steps		✓
SAFETY AND SECURITY			790 mm (31") triple grouser track shoes with additional steps		✓ ⁽¹⁾
Rear and right-side-view cameras	✓		Grease lubricated track link	✓	
360° visibility		✓	Center track guiding guard		✓
Ground level accessible secondary engine shutoff switch in cab	✓		Two-piece segmented track guiding guard		✓
Service platform with anti-skid plate and countersunk bolts	✓		Bottom without swivel guard	✓	
Signaling/warning horn	✓		Travel motor guards	✓	
Swing alarm		✓	3.57 mt (7,870 lb) counterweight	✓	
Hydraulic lock out lever	✓		Tie-down points (ISO 15818 compliant)	✓	
Inspection lighting		✓			

⁽¹⁾Europe only.

Dealer Installed Kits and Attachments

Attachments may vary. Consult your Cat dealer for details.

CAB

- Radial lower wiper (deluxe cab only)
- Left-hand and right-hand electrical pedal (two-way) for tool control
- Dual exit rear window kit
- Rain protector plus cab light cover
- Front windshield laminated glass (P5A glass, EU demolition regulation)
- Key fob (for use with Bluetooth receiver)

SAFETY AND SECURITY

- 76 mm (3") retractable seat belt

GUARDS

- FOGS (not compatible with cab light cover, rain protector)
- Mesh guard full front (not compatible with cab light cover, rain protector)
- Mesh guard lower front half
- Full protecting vandalism guard

Cab Options

	Deluxe	Premium* (2 piece windshield)	Premium* (1 piece windshield)
ROPS	●	●	●
High-resolution 254 mm (10") LCD touchscreen monitor	●	●	●
Auto bi-level air conditioner	●	●	●
Jog dial and shortcut keys for monitor control	●	●	●
Keyless push-to-start engine control	●	●	●
Height-adjustable console	●	●	●
Tilt-up left-side console	●	●	●
Heated air-suspension seat	●	X	X
Heated and ventilated air-suspension seat	X	●	●
51 mm (2") seat belt	●	●	●
Monitor integrated Bluetooth radio with USB/Aux ports**	●	X	X
Monitor integrated Bluetooth radio with USB/Aux ports/DAB*	●	●	●
12V DC outlets	●	●	●
Document storage	●	●	●
Overhead storage and rear storage with nets	●	●	●
Beverage holder	●	●	●
Cup holder	●	●	●
Openable two-piece front window	●	●	○
One piece front windshield	X	○	●
Rear window emergency exit	●	●	●
Radial wiper with washer	●	X	X
Parallel wiper	X	●	●
Openable polycarbonate skylight hatch	●	●	X
Laminated roof glass	X	X	●
LED dome light	●	●	●
Floor welcome light	●	●	●
Roof sunscreen	●	●	●
Roller front sunscreen	●	●	●
Roller rear sunscreen	○	●	●
Washable floor mat	●	●	●
Beacon ready	●	●	●
Cat Stick Steer	○	○	○
Auxiliary relay	○	○	○

● Standard

○ Optional

X Not available

*Europe only

**Australia and New Zealand only

317 Environmental Declaration

The following information applies to the machine at the time of final manufacture as configured for sale in the regions covered in this document. The content of this declaration is valid as of the date issued; however, content related to machine features and specifications are subject to change without notice. For additional information, please see the machine's Operation and Maintenance Manual.

For more information on sustainability in action and our progress, please visit <https://www.caterpillar.com/en/company/sustainability>.

Engine

- The Cat® C4.4 engine meets U.S. EPA Tier 4 Final, EU Stage V, and Japan 2014 emission standards.
- Cat diesel engines are required to use ULSD (ultra-low sulfur diesel fuel with 15 ppm of sulfur or less) or ULSD blended with the following lower-carbon intensity fuels up to:
 - ✓ 20% biodiesel FAME (fatty acid methyl ester)*
 - ✓ 100% renewable diesel, HVO (hydrogenated vegetable oil) and GTL (gas-to-liquid) fuels

Refer to guidelines for successful application. Please consult your Cat dealer or “Caterpillar Machine Fluids Recommendations” (SEBU6250) for details.

**Engines with no aftertreatment devices can use higher blends, up to 100% biodiesel.*

Air Conditioning System

- The air conditioning system on this machine contains the fluorinated greenhouse gas refrigerant R134a (Global Warming Potential = 1430). The system contains 0.9 kg (2.0 lb) of refrigerant which has a CO₂ equivalent of 1.418 metric tonnes (1.261 tons).

Paint

- Based on best available knowledge, the maximum allowable concentration, measured in parts per million (PPM), of the following heavy metals in paint are:
 - Barium < 0.01%
 - Cadmium < 0.01%
 - Chromium < 0.01%
 - Lead < 0.01%

Sound Performance

ISO 6395 (external) – 101 dB(A)

ISO 6396 (inside cab) – 70 dB(A)

- When properly installed and maintained, the cab offered by Caterpillar, when tested with doors and windows closed according to ANSI/SAE J1166 OCT98, meets OSHA and MSHA requirements for operator sound exposure limits in effect at time of manufacture.
- Hearing protection may be needed when operating with an open operator station and cab (when not properly maintained or doors/windows open) for extended periods or in a noisy environment.

Oils and Fluids

- Caterpillar factory fills with ethylene glycol coolants. Cat Diesel Engine Antifreeze/Coolant (DEAC) and Cat Extended Life Coolant (ELC) can be recycled. Consult your Cat dealer for more information.
- Cat Bio HYDO™ Advanced is an EU Ecolabel approved biodegradable hydraulic oil.
- Additional fluids are likely to be present, please consult the Operations and Maintenance Manual or the Application and Installation guide for complete fluid recommendations and maintenance intervals.

Features and Technology

- The following features and technology may contribute to fuel savings and/or carbon reduction. Features may vary. Consult your Cat dealer for details.
 - Advanced hydraulic systems balance power and efficiency
 - Smart mode matches machine power to digging requirements automatically
 - Eco mode minimizes fuel consumption for light applications
 - One-touch low idle with automatic engine speed control
 - Increase operating efficiency up to 45% with standard Cat technologies
 - New hydraulic oil filter provides longer life with a 3,000-hour replacement interval
 - Remote Flash and Remote Troubleshoot

For more complete information on Cat products, dealer services, and industry solutions, visit us on the web at www.cat.com

© 2022 Caterpillar
All rights reserved

Materials and specifications are subject to change without notice. Featured machines in photos may include additional equipment. See your Cat dealer for available options.

CAT, CATERPILLAR, LET'S DO THE WORK, their respective logos, "Caterpillar Corporate Yellow," the "Power Edge" and Cat "Modern Hex" trade dress as well as corporate and product identity used herein, are trademarks of Caterpillar and may not be used without permission.

AEXQ3026-03 (08-2022)
Replaces AEXQ3026-02
Build Number: 07C
(Eur, Aus-NZ)

